

# Bumpeez™

**360° ROTATION  
INFLATABLE BUMPER CAR  
WITH LIGHTS & SOUNDS**

**UNICORN**

**INCLUDES  
REMOTE CONTROL**

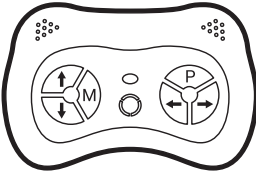

Remote Requires  
**2 AAA** batteries  
(Not included)

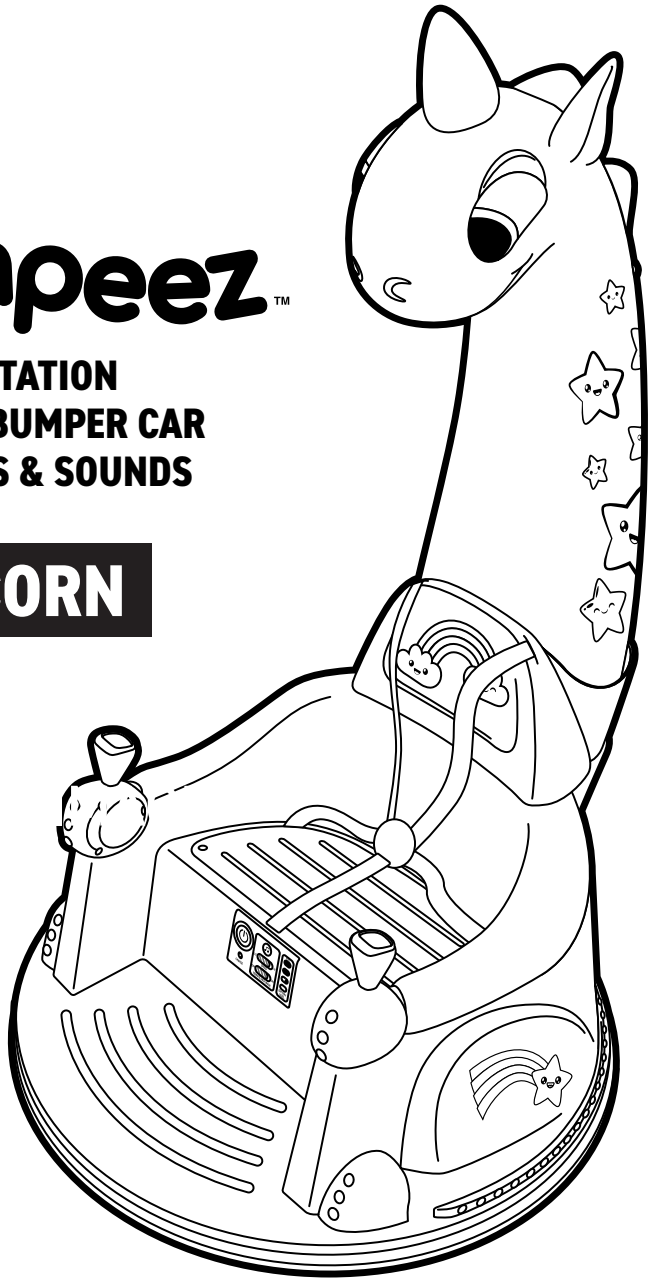

## **USER MANUAL**

**ADULT ASSEMBLY REQUIRED**

**KEEP THIS MANUAL HANDY FOR FUTURE REFERENCE**

<b>Specifications:</b>	
Motor	2 x 12V, 380 / 20,000 RPM
Battery	12V 4.5 AH
Charger	12V 500 MA
Speed	0.8-1.3 MPH (1.3-2.1 KPH)
Vehicle Size	23.5 x 23.5 x 18 in.
Charge Time	8 -12 hours
Age Range	18 months - 7 years
Gender	Unisex
Max User Weight	50 lbs/22.6 kgs
Max Battery Temp.	104°

**IMPORTED BY**

RUBY INNOVATIONS LLC

BROOKLYN, NY

[www.bumpeeetoys.com](http://www.bumpeeetoys.com)

**Utility & Design Patents Pending**

Please read the User Manual  
carefully and enjoy!

We'd love to hear from you! If you have any  
thoughts about how we can improve our  
products, we're listening.

Call or text: (718) 814-1010  
Email: [cs@bumpeeetoys.com](mailto:cs@bumpeeetoys.com)

Scan this code to start a  
WhatsApp chat:



## General Warnings

### **Assembly:**

- Assembly must be completed by an adult.
- Read each step of the assembly instructions and follow the proper order.
- Before getting started, make sure you have all included parts and components.
- The packaging and plastic wrapping on all parts are not part of the toy and should be discarded.
- Ensure the packaging and parts are safeguarded away from children to prevent choking and suffocation hazards.
- Ensure all parts are assembled correctly.
- When assembly is complete, make sure all pieces are secured and the product is sturdy before use.

### **When Riding:**

- Children should always be supervised by an adult when riding the Bumper Car.
- The maximum weight for riders is 50 lbs/22.6 kg.
- For maximum safety, we recommend using protective wear such as a helmet to prevent injury from impact or misuse.
- This Bumper Car should only be used on level surfaces and in safe environments. Avoid areas that pose safety concerns such as slippery surfaces, public roads, raceways, high traffic areas, swimming pools, and large bodies of water.
- Children should ride in daytime hours or well-lit areas so they can easily see the ground and obstacles, and others can see them.
- Properly use the seatbelt provided to secure the child into the Bumper Car.
- For safety, make sure riders keep their hands, feet, hair, and loose clothing away from moving parts on the Bumper Car.
- Car will automatically shut off after idling for 10 minutes. To restart push power button to OFF and then back ON.

### **Cleaning & Storage:**

- This Bumper Car can be cleaned with a damp cloth. Do not immerse this item or any of the parts in water or liquid.
- Do not leave or store outdoors or expose to rain or extreme weather.

# Parts Included:



**TOOL REQUIRED:**  
Philips screwdriver  
(not included)



**H**

Seat Back Screws X2



**F**

Joystick Caps X2



**I**

Remote Control

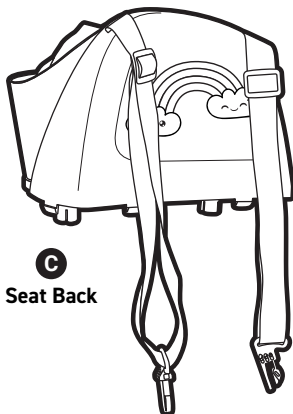

**C**

Seat Back



**G**

Joystick Screws X2

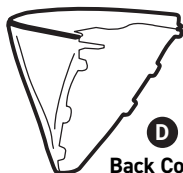

**D**

Back Cover



**E**

Joystick X2

**A**

Bumper Car

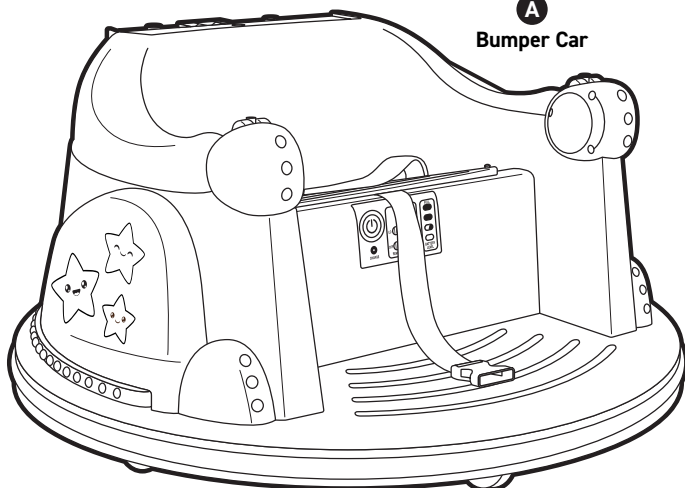

**B**

Charger

# Assembly Instructions:

## 1. Assemble Back Cover

1. Attach back cover to back of bumper car. Push bottom tab first.
2. Push top 2 tabs into slots on top.  
Make sure all tabs are secure.

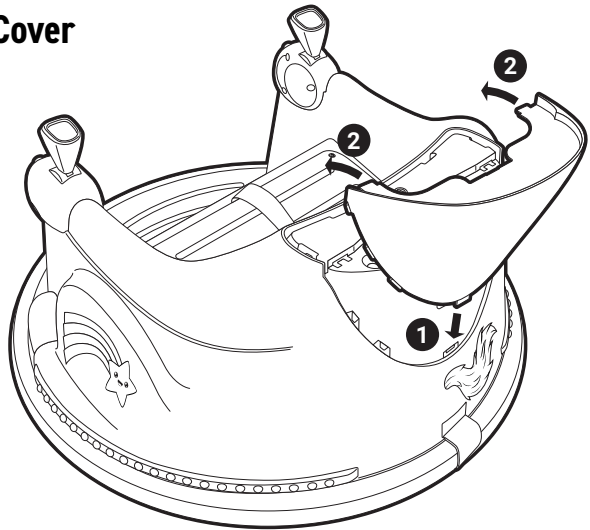

## 2. Assemble Back Rest

1. Connect the wire from the bumper car to the wire from the back rest as shown.
2. Press seat back firmly into slots as shown. Snap front first, then back.
3. Secure with 2 screws using Philips screwdriver.

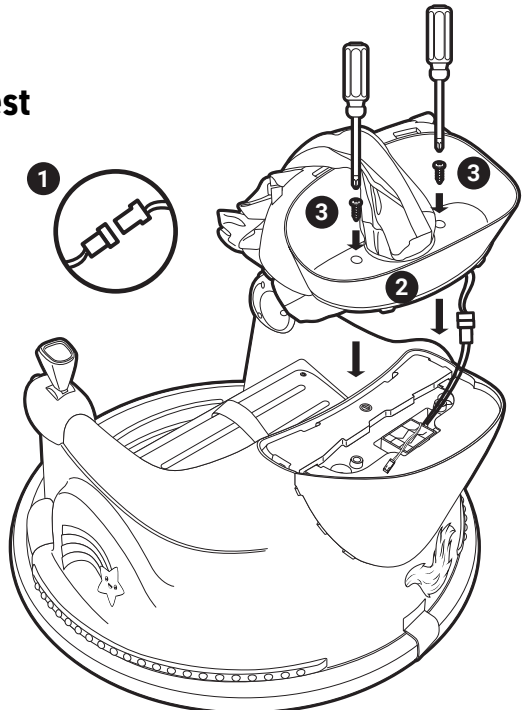

# Assembly Instructions:

## 3. Connect and Activate Battery

1. Remove the seat cover by unscrewing the 2 screws. This will give you access to the wire and battery terminal.
2. Connect the red wire to the red battery terminal as shown.
3. Re-attach the seat cover with the 2 screws using a Philips screwdriver.

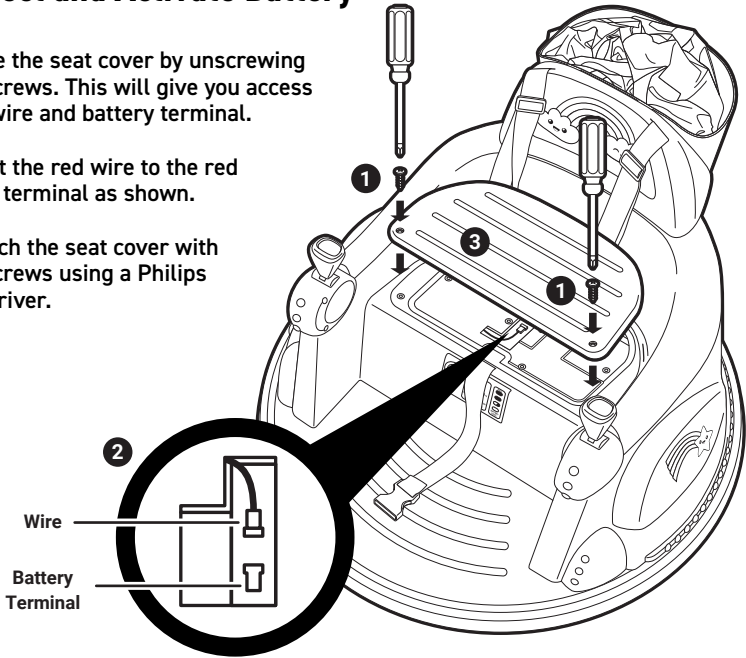

## 4. Charge the Battery

1. Plug the charging cable into the charging port located under the power button.
2. Charge using a standard power outlet.
3. Make sure the battery level lights on the control panel are blinking while the vehicle is charging. Lights turn solid when fully charged. Each light represents 25% charge. When all 4 lights are solid vehicle is fully charged.

### Control Panel

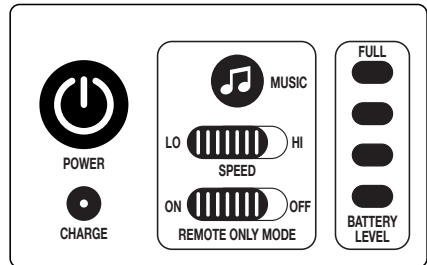

4. Allow the battery to fully charge for 8 -12 hours. Vehicle will not operate while the battery is charging. **\*Do not charge the battery for more than 20 hours. \* It is normal for the charger to feel warm when charging.**

# Assembly Instructions:

## 5. Assemble Joystick

1. Push the two joysticks into the slots on both sides of the vehicle with the front of the joystick angled as shown.
2. Secure the joysticks to the vehicle using the joystick screws.
3. Push joystick caps onto the joysticks.

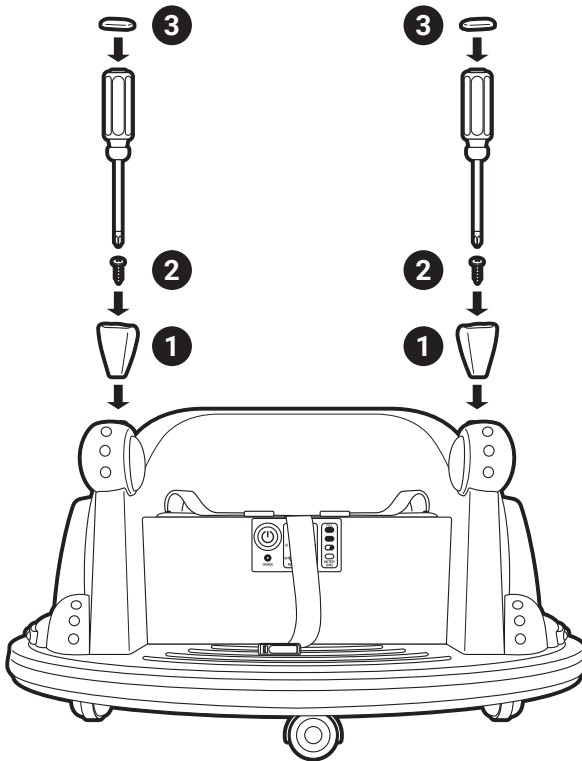
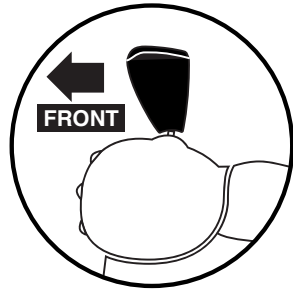

# Operating Your Bumper Car

1. Make sure the charging cable has been disconnected from the vehicle.
2. Turn on the vehicle by pressing the red power button located on the control panel.
3. Control the vehicle by pushing or pulling the joysticks forward or backward. Each joystick operates the corresponding wheel. See moves below:

**Move both joysticks forward . . . . . Moves vehicle forward**

**Move both joysticks backward . . . . . Moves vehicle backwards**

**Move one joystick forward . . . . . Slowly turns vehicle**

**Move one joystick forward and  
move one backward simultaneously . . . . . Quickly turns vehicle**

**Release both joysticks back to center position . . . . . Stops vehicle**

4. Switch the speed button to change speed levels from Slow (0.8 MPH) to Fast (1.3 MPH).
5. Press the music button to turn the music on or off.
6. Switch the Remote Only Mode button to ON to disable the joysticks on the vehicle and take full control of the vehicle by remote control. Switch the Remote Only Mode button to OFF to allow joystick operation.

**NOTE:**  
Vehicle will automatically shut off after idling for 10 minutes. To restart press the power button.

## Control Panel

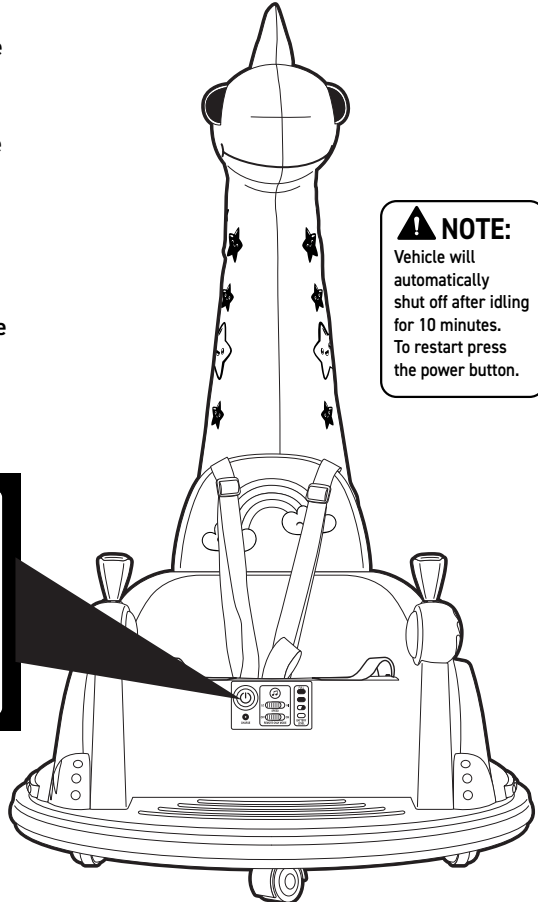
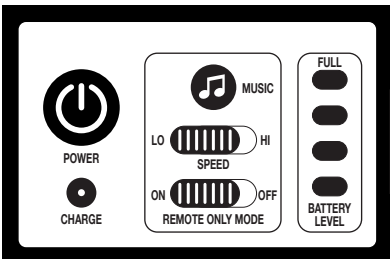



# Operating Your Bumper Car

## Remote Control Functions:

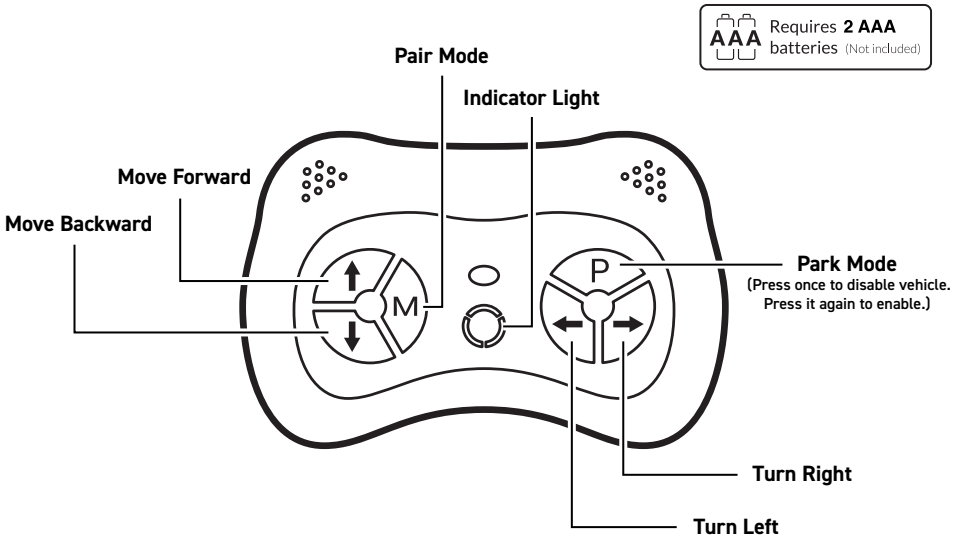

### Install Batteries:

Using Philips screwdriver (not included), remove screw on back of remote. Remove battery cover and Install 2 (two) AAA (1.5V) batteries (not included). Do not mix old and new batteries.

### Pairing:

Bumper Car ships with the remote already paired. In case you need to re-pair it do the following:

1. Long press the "M" button for 2 - 4 seconds. Indicator light will flash
2. Press the power button on the vehicle. Indicator light will flash, then go solid to indicate pairing successful
3. If pairing fails (indicator light remains flashing), remove the batteries and reinstall. Repeat steps 1 - 3.

Remote control will go into power saving mode after 10 seconds of non-use.

### Button Description:

- |               |            |  |
|---------------|------------|--|
| Move Forward  | Turn Left  | <b>M</b> Pair Mode   |
| Move Backward | Turn Right | <b>P</b> Park Mode<br>(Press once to disable vehicle. Press it again to enable.) |

# Troubleshooting

Problem	Analysis	Solution
Vehicle does not start/move	Low battery voltage Failed battery/engine  Wire disconnected  Vehicle is in "park" mode	Charge battery fully Check battery for damage, contact customer service  Check to make sure wire is connected properly  Push "P" on remote to disable "park" mode
Vehicle keeps stopping after a short time	Low battery voltage Faulty battery	Charge the battery fully Replace the battery
Vehicle runs at slow speed	Low battery voltage Faulty battery Overload  Vehicle is operating on uneven surface	Charge the battery fully Replace the battery Make sure rider's weight is under 50 lb limit  Operate vehicle on even and flat surface
Vehicle needs assistance to move forward	Faulty battery  Faulty motor	Make sure wire is connected and battery is fully charged Contact customer service
Loud grinding or clicking sound from the motor or gears	Faulty motor or gears	Contact customer service
Battery cannot be charged	Faulty battery Faulty battery or charger connection  Inoperable charger	Contact customer service Check to make sure wire is firmly connected and power source is firmly connected to the outlet when charging  Replace charger
Remote control is not working	Remote control battery is dead  Remote control is not paired	Replace the batteries  Re - Pair the remote control (see Page 9 for instructions)

## FCC Statement (United States Only)

This equipment has been tested and found to comply with the limits for a Class B digital device, pursuant to Part 15 of the FCC Rules. These limits are designed to provide reasonable protection against harmful interference in a residential installation. This equipment generates, uses and can radiate radio frequency energy and, if not installed and used in accordance with the instructions, may cause harmful interference to radio communications. However, there is no guarantee that interference will not occur in a particular installation. If this equipment does cause harmful interference to radio or television reception, which can be determined by turning the equipment off and on, the user is encouraged to try to correct the interference by one or more of the following measures:

- Reorient or relocate the receiving antenna.
- Increase the separation between the equipment and receiver. Consult the dealer or an experienced radio/TV technician for help.

Note: Changes or modifications not expressly approved by the manufacturer responsible for compliance could void the user's authority to operate the equipment. This device complies with Part 15 of the FCC Rules. Operation is subject to the following two conditions: (1) this device may not cause harmful interference and (2) this device must accept any interference received, including interference that may cause undesired operation.

# 1 Year Limited Term Warranty

## Warranty Terms

RUBY INNOVATIONS LLC warrants that its merchandise is free from manufacturing defects (workmanship and / or material) and will either give credit or replace defective parts for a period of up to one (1) year from the date of purchase in accordance with the conditions set forth below. If a manufacturing defect is found, RUBY INNOVATIONS LLC should be notified promptly of the defect and supplied a copy of the invoice and delivery ticket. Inspection by a RUBY INNOVATIONS LLC employee or representative may be necessary to verify that a manufacturing defect exists, or you may be required to submit samples to RUBY INNOVATIONS LLC along with a digital image of the defects. If replacement is required in accordance with this warranty and the defective material or merchandise has been discontinued or unavailable, RUBY INNOVATIONS LLC reserves the right to select and supply similar merchandise or offer full credit for the merchandise; otherwise the same material or merchandise will be supplied for replacement purposes. This warranty is made solely to the retailer and is not transferable under any circumstances. It is the retailer's responsibility to contact RUBY INNOVATIONS LLC with a claim. We will not handle claims from consumers directly; all requests must go through the retailer who sold the merchandise to the consumer. We advise all retailers to retain invoices for a minimum of one (1) year for warranty purposes. This warranty supersedes and replaces all implied warranties of merchantability and use for particular purpose. No representative, employee, agent or any other person is authorized to assume for RUBY INNOVATIONS LLC any additional liability or responsibility in connection with RUBY INNOVATIONS LLC's merchandise except as described above. Implied warranties of merchantability and fitness of the merchandise are limited to a period of one (1) year from the date of purchase in no event shall RUBY INNOVATIONS LLC be liable for indirect, consequential or incidental damages of any kind.

## Additional Conditions:

THE FOLLOWING EXAMPLES ARE NOT MANUFACTURER'S DEFECTS:

Colors may vary slightly from the photo because of photography and printing tolerances.

Sizes stated in US standard measurements may vary slightly due to products that are manufactured using the metric system.

No returns for buyer's remorse.

No returns - other than stated above will be accepted.

## Warranty is Void for Any of the Following Conditions:

Improper maintenance or improper use resulting in damage.

Any product modifications by dealer, consumer, or other parties not authorized by RUBY INNOVATIONS LLC will void this warranty.

Floor samples sold or products designated "AS IS" at the time of purchase are not covered by the warranty

Warranty does not cover minor variations or differences between floor samples or printed illustrations and your product.

Cost of packaging and shipping to and from RUBY INNOVATIONS LLC is not covered by the warranty unless expressly arranged by RUBY INNOVATIONS LLC.

This warranty covers only articles of appliances intended for residential use only, and does not cover any industrial, commercial, institutional or rental use.

Dissatisfaction due to buyer's remorse.

Normal wear and tear.

Damages incurred during transportation.

Damages incurred during assembling or maintenance.

Damage incurred by accidents or abuse.

